

This product is intended for installation only by expert users. Please consult with a qualified technician for installation. Improper installation may result in damage to your equipment. Before you start using this product please follow these basic guidelines:

1. Please carefully read through the instruction manual before beginning the installation process.
2. Please remove your graphics card from your motherboard to ensure the safest process and in order to prevent any possible damages to your CPU and motherboard.
3. It is strongly recommended to use market proven pre-mix coolant, such as Thermaltake Coolant 1000.

Parts List

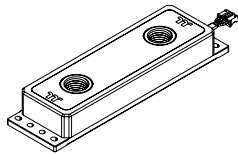

A x 1
Water Block

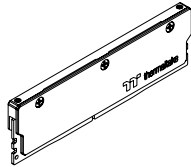

B x 4
Memory Module



C x 8
Screw

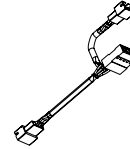

D x 1
LED Y-Cable

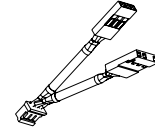

E x 1
MB SYNC Cable

Installation Guide

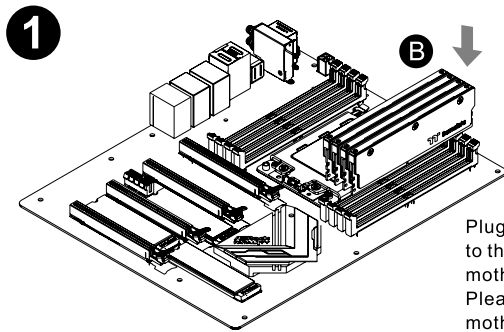

1 Plug the Memory Module(B) to the DDR4 slot on the motherboard. Please refer to the motherboard manual for the installation location.

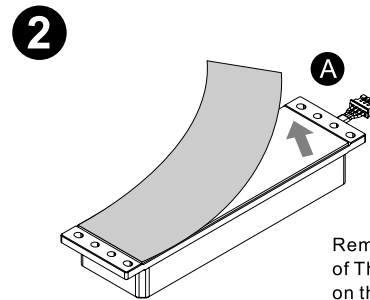

2 Remove the protective film of Thermal Pad on the Water Block(A).

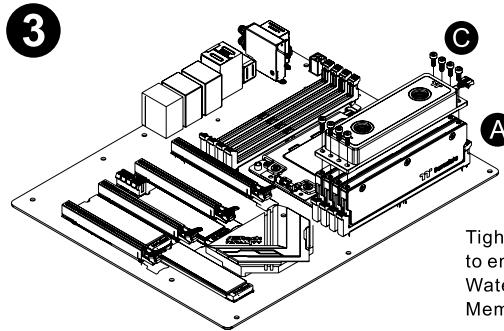

3 Tighten the Screws(C) to enclose the Water Block(A) and Memory Module(B).

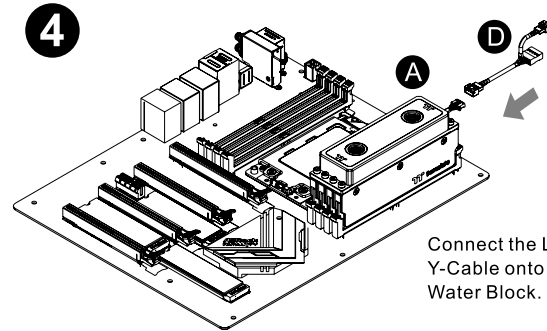

4 Connect the LED Y-Cable(D) onto the Water Block.

Motherboard SYNC installation Guide

CAUTION

Please power off the PC and check the Positive and Negative ends on the connector before connecting the cable to motherboard. Connecting the wrong end can damage the LEDs.

Connect the MB SYNC Cable (D) to LED Y-Cable (E)

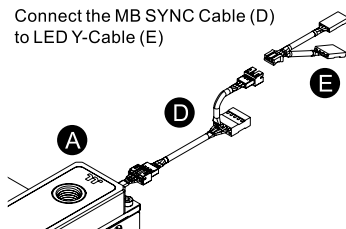

ASUS
Aura Addressable Strip Header(s)

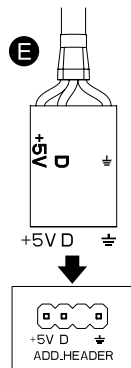

MSI
JRGB-strip Header(S)

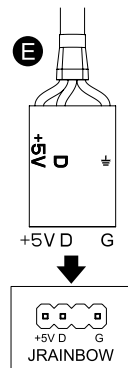

ASROCK
Addressable RGB LED Header(s)

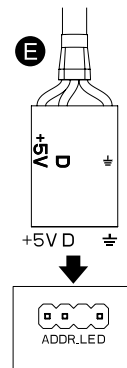

GIGABYTE
AORUS RGB Fusion with Digital LEDs

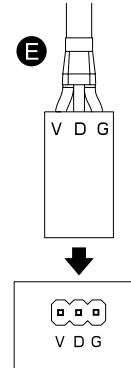

Parts List

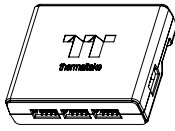

F x 1
Controller

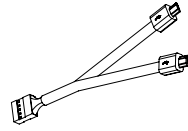

G x 1
Controller Cable

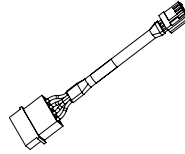

H x 1
Power Cable

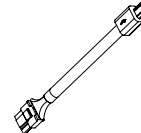

I x 1
Bridge Cable

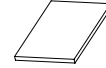

J x 1
Velcro

Installation Guide

5

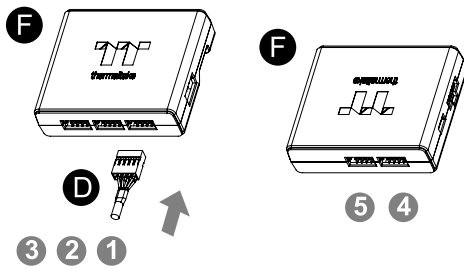

Connect the Waterblock onto the controller.

6

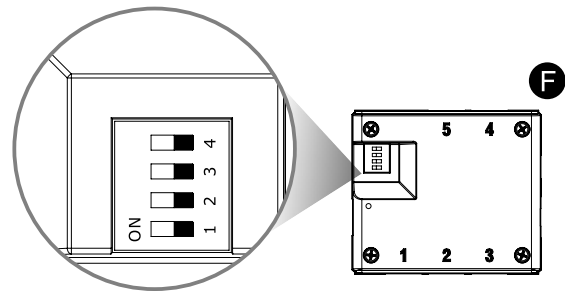

Set the DIP switch on the back side of the controller to assign the number of the controller

7

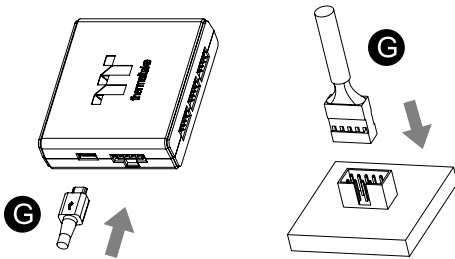

Connect the controller cable onto the motherboard (USB 2.0 9 pin) and controller.

8

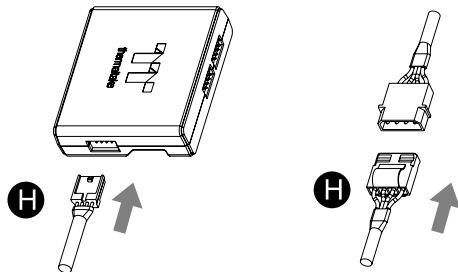

Connect the power cable to the 4pin Molex connector and controller.

9

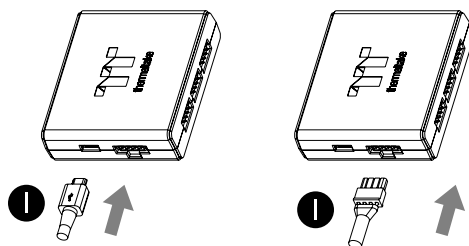

If you want to connect two or more controllers, you can use the bridge cable to connect the controllers.

NO.1

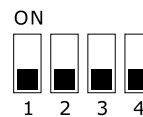

NO.2

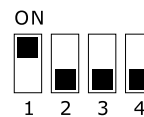

NO.3

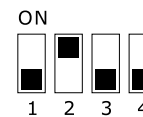

NO.4

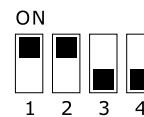

NO.5

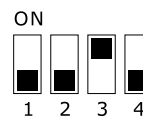

NO.6

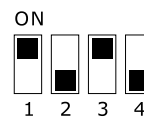

NO.7

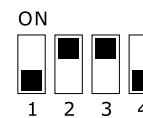

NO.8



NO.9

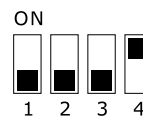

NO.10

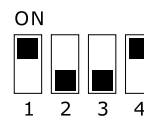

NO.11

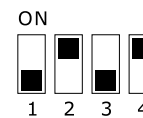

NO.12



NO.13

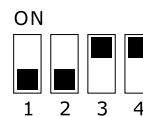

NO.14

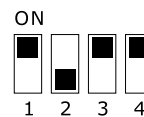

NO.15



NO.16

